



AECAP

CAPACITIVE LEVEL TRANSMITTER

## Application Areas:

Liquid tanks, food machines, cooling liquid tanks, shipping, glycol tanks, brine, waste water tanks.

Oil tanks, CO2 liquid tanks, high temperature tanks, non-conductive liquids.

Grain stores, cement, sand feed, flour, milk powder, organic and plastic granule.

## AECAP - CAPACITIVE LEVEL TRANSMITTER

AECAP 101 / 102 / 103 / 107 / 109

AECAP 202 / 203 / 204 / 205 / 209

AECAP 304 / 305 / 306 / 309 / 30S

AECAP 408A / 408B / 408P / 408T

## Advantaages:

- There are no moving parts.
- High pressure and temperature resistant design.
- Modular structure with easy assembly.
- Not affected by foam, liquid splashes.
- Not affected by vibration, has robust mechanical structure.
- Zero Span adjustment is easy.
- Measurement along whole sensor.
- Operability with reverse assembly.

## Technical Specifications:

Measurable Material	Conductive liquids Low conductive liquids Solids particulate materials Adhesive and acid/basic liquids
Supply	9-36 VDC
Signal Output	4-20mA two wire Std. 0-20mA - 4-20mA, 0-10 V three wire Opt.
Accuracy	± % 0,5, ± % 0,8, ± % 1
Linearity	% 0,5
Capacity Range	1pF...3nF
Min. Di-Elektric Constant	1,6 ε <sub>r</sub>
Connection Material	304 Stainless Steel Opt.316 Stainless Steel
Isolation Material	PFA Std. Opt. PEEK, PTFE, Rubber, FKM
Housing Material	PBT Std., Opt. Aluminium, Stainless Steel
Working Pressure	(-)1...100 bar (Depending on the model)
Working Temperature	(-) 40 / (+) 150°C (Depending on the model) 200°C with cooling apparatus. (-) 196° for Cryogenic Tank (-) 50...+80 °C for NBR FKM (-) 30...+ 200 °C 400 °C with ceramic isolation
Ambient Temperature	(-)20 / (+) 60 °C
Display	with LED-Power and Contact LED
Isolation	Max. 500 W
Power Consumption	Max. 50mW
Electrical Connection	Clemens
Protection Class(EN60529)	PBT – IP 66, Aluminium, Stainless Steel IP 65
Test	EMC, Low voltage
Max. Tensile Force	Max. 40 NM
Weight	295gr. for AECAP 101 250 mm.

### Working Principle:

Capacitance definition, assuming two parallel conductive plates are used;

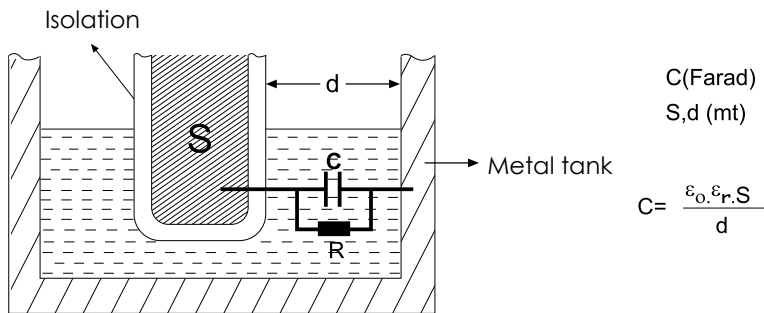

However, there are scarcely any sensor type which this definition can be practically utilized. Above Formula can no longer be reliable especially when residual areas increase due to large distance (d) (which is usually the case). Thus, measuring impedance for distance measurements give more accurate results than capacitance measurement.

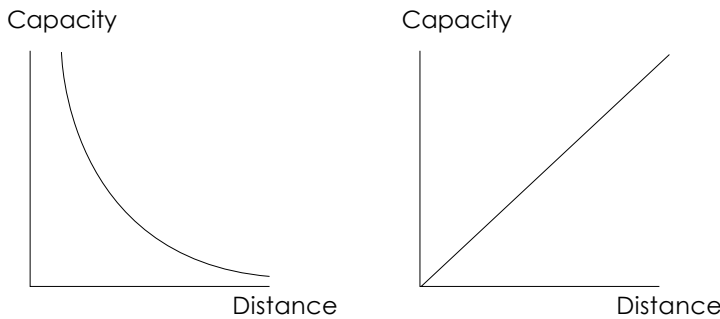

Impedance definition  $Z = R + jL\omega + (jC\omega)^{-1}$  R is defined as real component and represent ambient conductivity.

$jL\omega$  second component is defined as inductive reactance. This component is present even if we perform capacitive measurement. However we neglect this. Since we evaluate results based on electrostatic properties of the environment, no error will occur. Resulting impedance definition is

$$Z = R + (jC\omega)^{-1}$$

Measurement is made by charge transfer in our capacitive sensors. Total impedance is defined as  $Z = V / I$ . I (current)  $I = Q/t$   
 Q (Coulomb)  
 T (sec)

Capacitive reactance we desire to measure is  $(jC\omega)^{-1}$ . Meaning that charge and impedance have the same phase. To summarize, charge transferred to medium is directly proportional with capacitive reactance. For sensors manufactured as coaxial;

- a: Central electrode radius
- b: Outer screen radius
- L: length

$$C = \frac{2 \cdot \pi \cdot \epsilon_0 \cdot \epsilon_r}{\ln(b/a)} \cdot L$$

Impedance is calculated by this definition

Excitation applied between 10KHz–250KHz based on length for all our models. ( $\omega = 2\pi f$ ) Linearity error that may be caused by conductivity component (R) effect is prevented by electronic circuit design and mechanical design. Reduced to a level lower than 1ppm, acceptable as zero.

Process Pressure / Temperature Chart

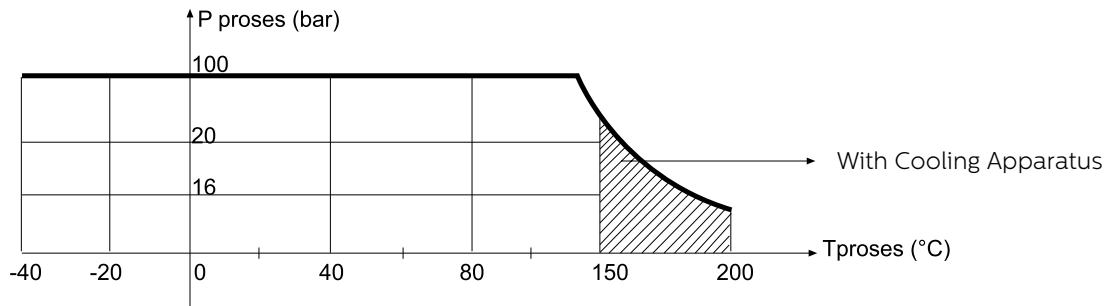

Environment Pressure / Temperature Chart

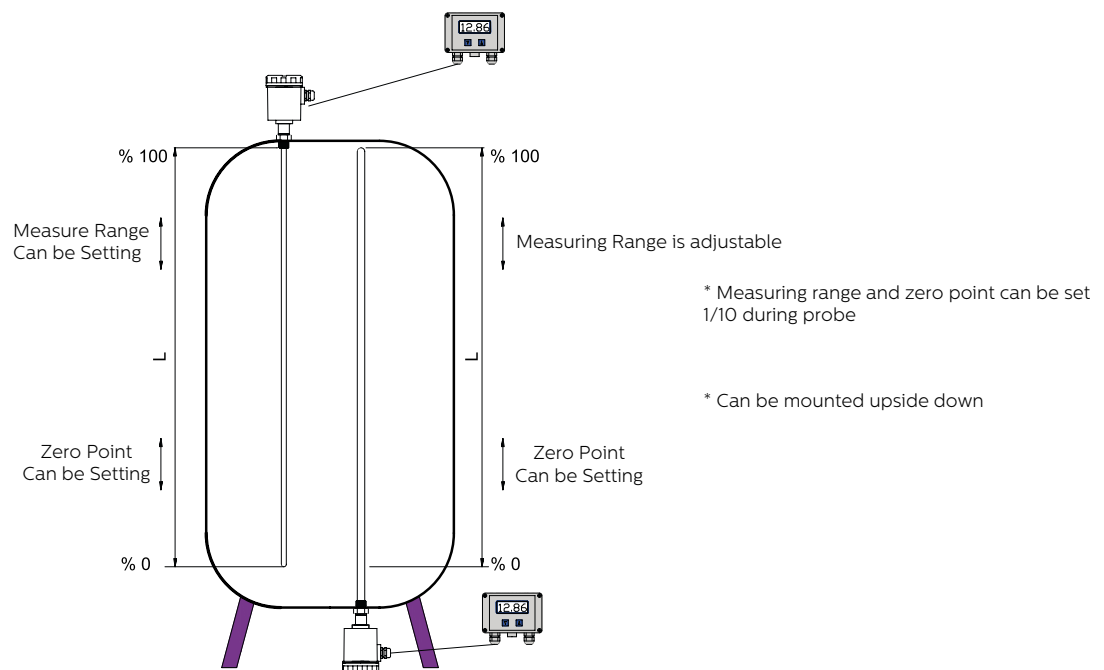
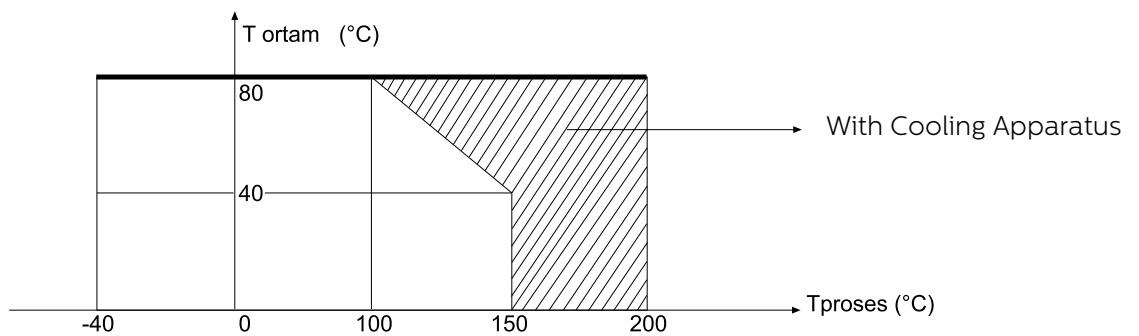

Application Examples :

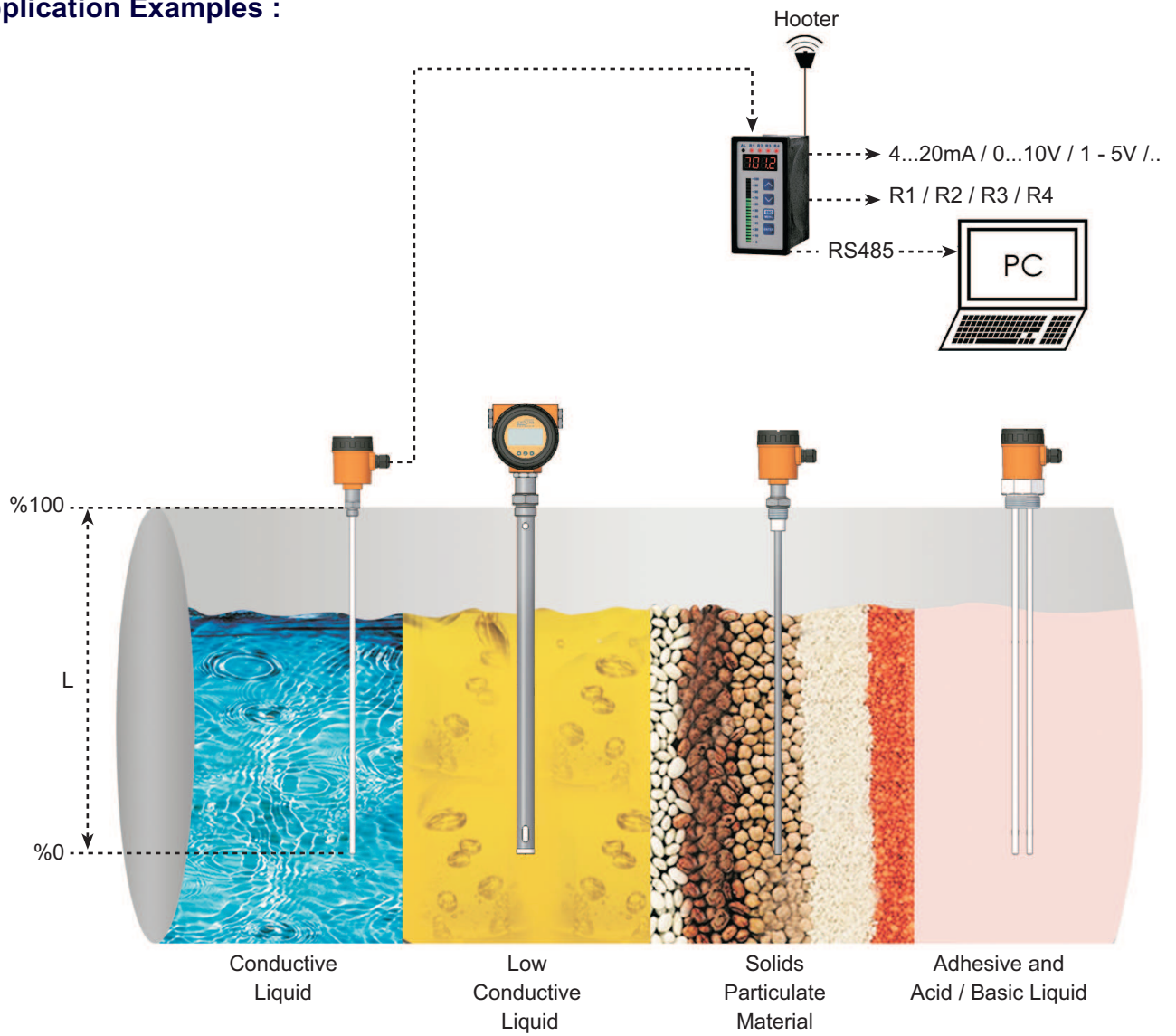

**Parts:**

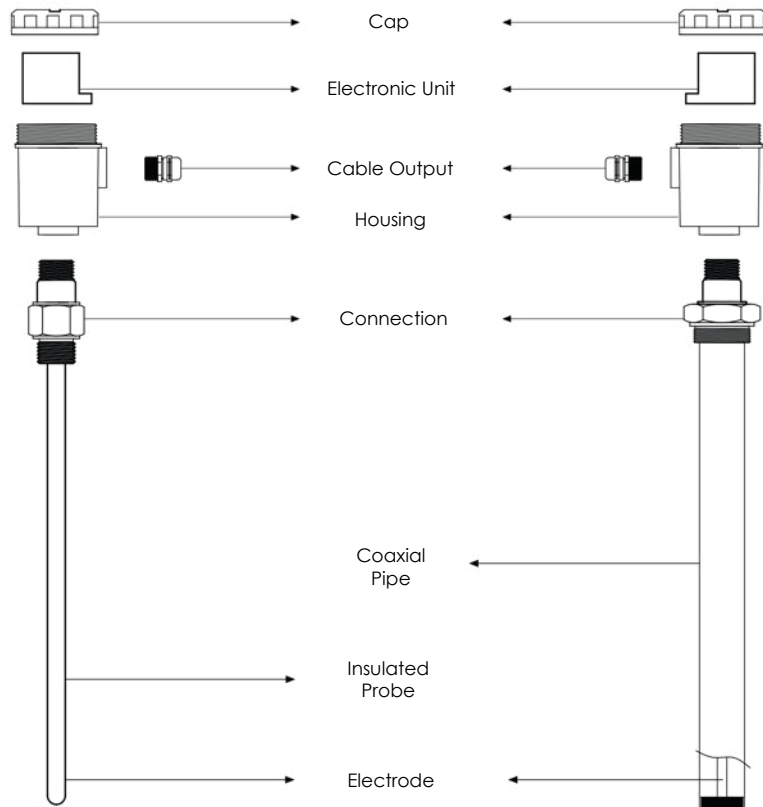

**Cooling:**

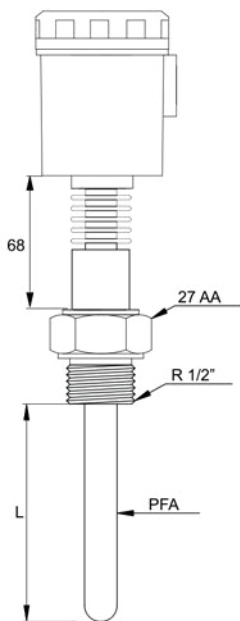

**Electronic Unit with Cable:**

Electronic unit and sensor component can be separated by a cable that protected against exterior conditions for easy calibration on site. Thanks to the properties of cable, easy assembly for user is possible without affecting capacitive measurement.

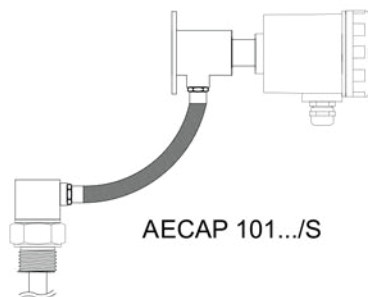

**B010 Aluminium Housing (For Double Cell)**

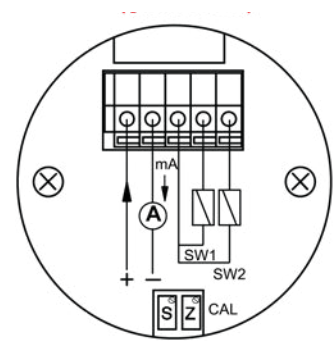

4-20 mA Two Wire + 2 PNP NO

## Electrical Connection:

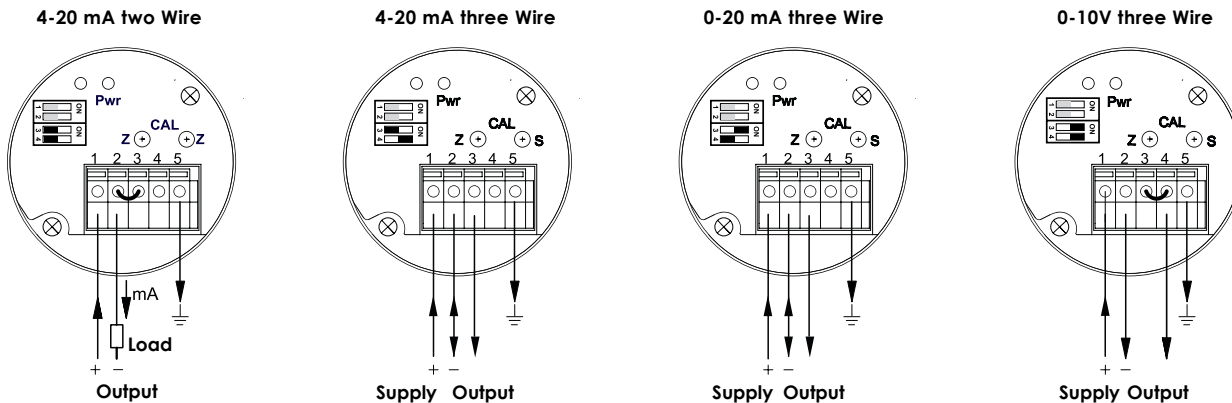

### Identification of Calibration Buttons:

Z (Starting Range-Zero) : Measurement starting point - 4mA

Zero adjustment (zero): 4mA adjustment is performed at factory exit, assuming tank is completely empty. If adjustment is needed again, 4mA output adjustment can be performed by Z calibration after the tank is filled until initial level.

S (Measuring Range-Span): Measuring peak point - 20mA

Measurement field (span) adjustment: 20mA is adjusted at factory exit, assuming tank is filled up to length of electrode. If adjustment is needed again, 20mA output adjustment can be performed by S calibration after filling the tank up to a desired level.

### Switch Settings of Output Signal:

When setting output signal, only the 3rd and 4th switches are active and configuration is defined only if the circuit energized.

Power Supply : 9-36VDC

Max. Load Resistance :  $(R_L) = (V_{sup} \div 3) / 0.02 [\Omega]$

Changes are not effective during normal operation.



4-20mA Two Wire



4-20mA Three Wire



0-20 mA Three Wire

or



0-10 V Three Wire

### Calibration:

Only the switch 1 is active at first. When SW1 brought into "ON" position, red led light starts winking with 1 second interval. Zero level adjust (SW1 is on position): Z button must be kept pressed until the green led is flashed.

Span level adjust (SW1 is on position): S button must be kept pressed until the green led is flashed.

After calibration, when SW1 brought into off position, it saves settings to memory and turn back into normal working condition.



S → Span Level

Z → Zero Level

SW3 and SW4 positions have no effect on calibration.

**Housing:**

Plastic

**B10p**

Aluminium

**B10x**

Stainless Steel

**B101x**

Aluminium(Double CELL)

**B010**

TYPE	MATERIAL	PROTECTION CLASS	TEMPERATURE (°C)	SIZE a x b x c (mm)
B10p	Plastic (PBT)	IP 65 / IP 67	-40...+150	96 x 77
B10x	Aluminum	IP 65	-40...+150	96 x 77
B101x	Stainless Steel	IP 65	-40...+150	108 x 79
B010	Aluminum (Double Cell)	IP 68	(-)40...+ 100	91 x 116

**Mechanical Connection :**

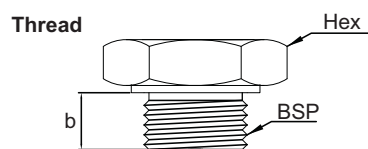

(ISO228-1)

Dimension	Hex [mm]	Thread b [mm]
BSP		
1/2"	27	14
3/4"	32	14
1"	41	23
1 1/4"	51	23
1 1/2"	60	23
2"	70	23

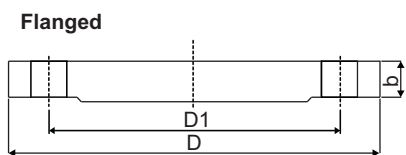

(ISO1092-1)

PN 16	D (mm)	D1 (mm)	b (mm)
DN25	165	85	16
DN50	165	115	18

(ISO1092-1)

PN 40	D (mm)	D1 (mm)	b (mm)
DN25	115	85	18
DN32	140	100	20
DN50	165	125	20
DN80	200	160	20
DN100	235	190	24

(ANSI B16.5)

PN 40	D (mm)	D1 (mm)	b (mm)
DN50	152,4	121	19
DN80	190,5	152,4	23,8
DN100	228,6	157,2	23,8

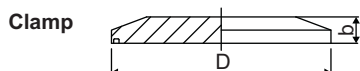





(ISO2852)

Dimension	Dia. D (mm)	b (mm)
DN32	50,5	32
DN50	64	50
DN65	91	65



Sample Models:

		Measuring Range	Probe	Process Pressure / Temp.
<b>CONDUCTIVE LIQUIDS</b>	<b>AECAP 101</b> 0...4mt.		Fully Insulated Conductive Tank	-1...+100 bar -40...+150°C
	<b>AECAP 102</b> 0...4mt.		Fully Insulated Coaxial Probe Insulated Tank	-1...+100 bar -40...+150°C
	<b>AECAP 103</b> 0...1mt.		Fully Insulated Coaxial Probe Insulated Tank	-1...+100 bar -40...+150°C
	<b>AECAP 107</b> 0...32mt.		Fully Insulated Rope Conductive Tank	-1...+60 bar -40...+150°C
	<b>AECAP 109</b> 0...32mt.		Fully Insulated Double Rope Insulated Tank	-1...+60 bar -40...+150°C

**Sample Models:**

AECAP 101

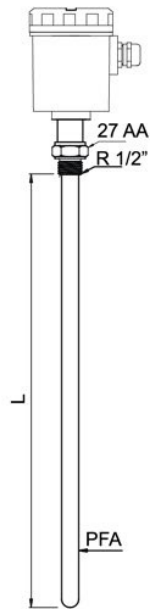

AECAP 102

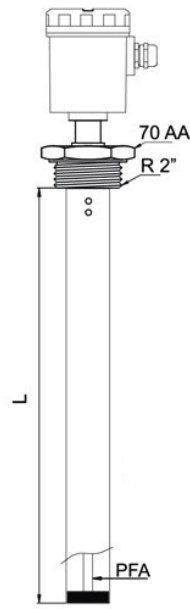

AECAP 103

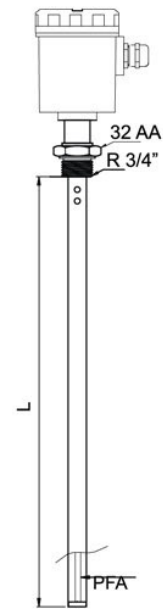

AECAP 107

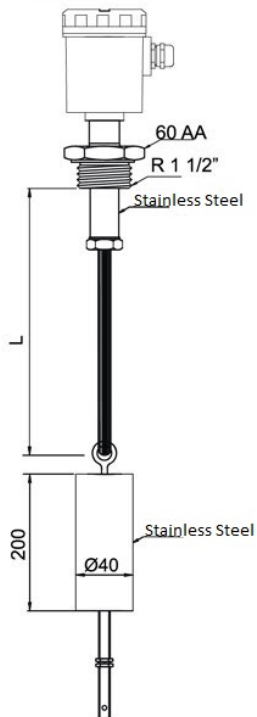



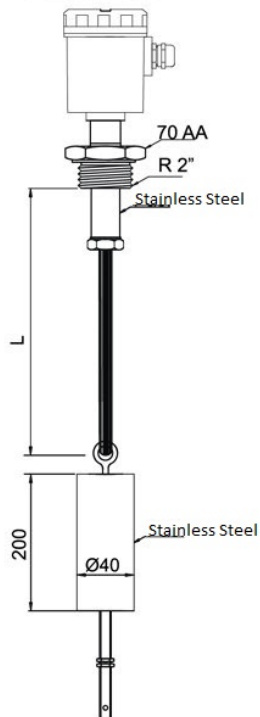

AECAP 107

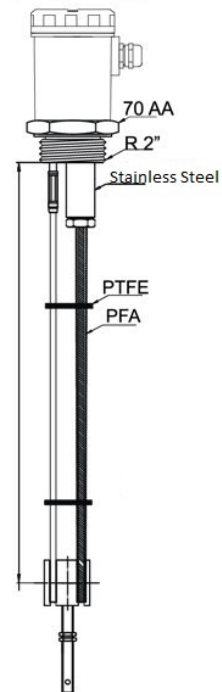

AECAP 109



Sample Models:

Measuring Range		Probe	Process Pressure / Temp.
<b>NONCONDUCTIVE LIQUIDS</b>	<b>AECAP 202</b> 0...4mt. 	Partly Insulated Coaxial Probe Conductive/Insulating Tank	-1...+100 bar -40...+150°C
	<b>AECAP 203</b> 0...1mt. 	Partly Insulated Coaxial Probe Conductive/Insulating Tank	-1...+100 bar -40...+150°C
	<b>AECAP 204</b> 0...32mt. 	Partly Insulated Rope Conductive Tank	-1...+60 bar -40...+150°C
	<b>AECAP 205</b> 0...6mt. 	Partly Insulated Probe Conductive Tank	-1...+100 bar -40...+150°C
	<b>AECAP 209</b> 0...32mt. 	Partly Insulated Double Rope Conductive/Insulating Tank	-1...+60 bar -40...+150°C

**Sample Models:**

**AECAP 202**

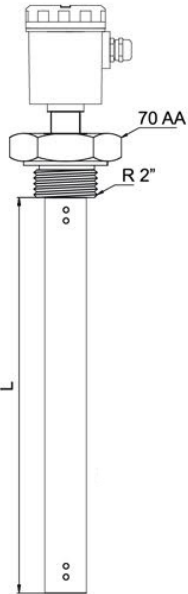

**AECAP 203**

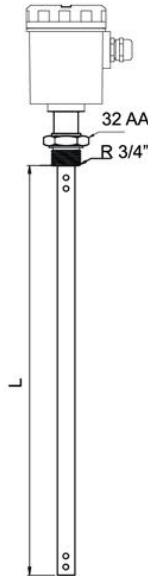

**AECAP 205**

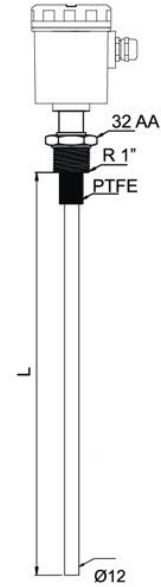

**AECAP 204**

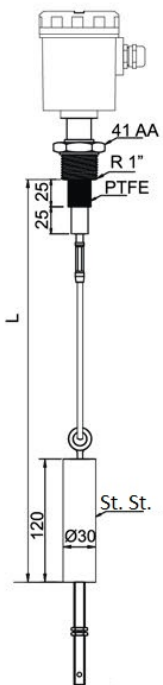

**AECAP 204**

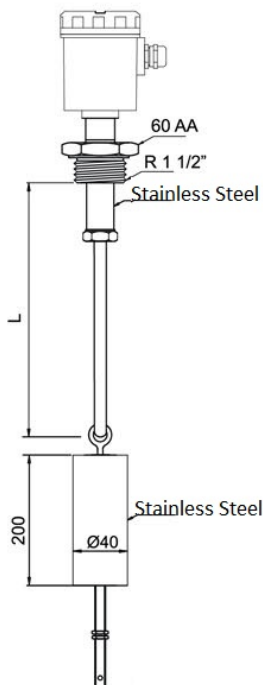



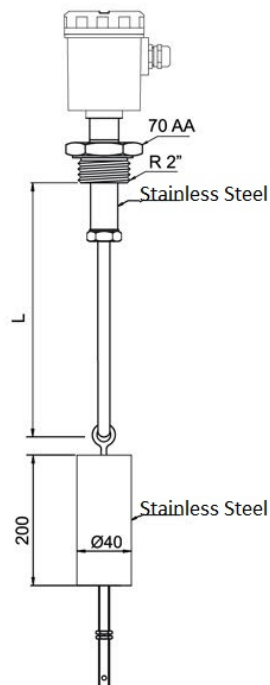

**AECAP 204**

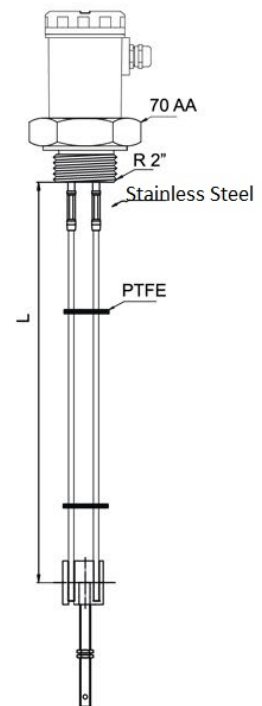

**AECAP 209**



Sample Models:

		Measuring Range	Probe	Process Pressure/Temp.
<b>SOLIDS PARTICULATE MATERIALS</b>		<b>AECAP 304</b> 0...32mt. 	Partly Insulated Rope Conductive Tank	-1...+60 bar -40...+150°C
		<b>AECAP 305</b> 0...6mt. 	Partly Insulated Probe Conductive Tank	-1...+60 bar -40...+150°C
		<b>AECAP 306</b> 0...1mt.  High Temp.	Partly Insulated Probe Conductive Tank	-1...+25 bar -40...+200°C
		<b>AECAP 309</b> 0...32mt. 	Fully Insulated Double Rope Insulated Tank	-1...+60 bar -40...+150°C
		<b>AECAP 30S</b> 0...4mt.  High Temp.	Partly Insulated Probe Conductive Tank	-1...+25 bar -40...+400°C

## Sample Models:

AECAP 305

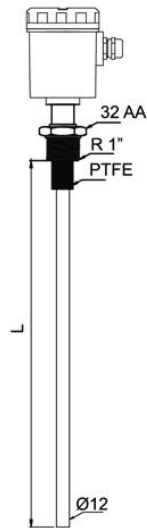

AECAP 306

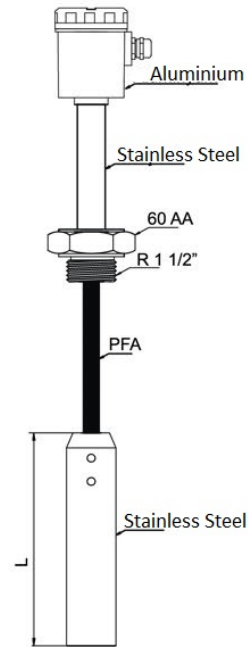

AECAP 304

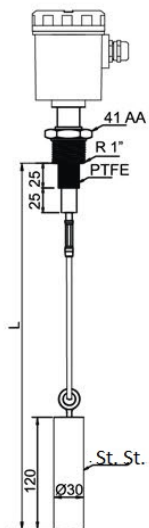

AECAP 304

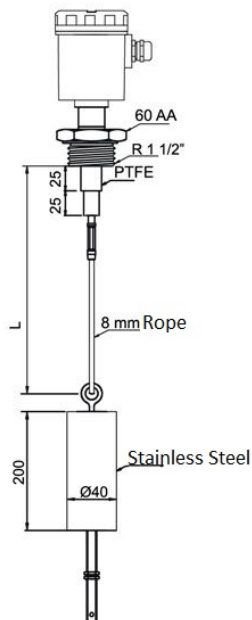



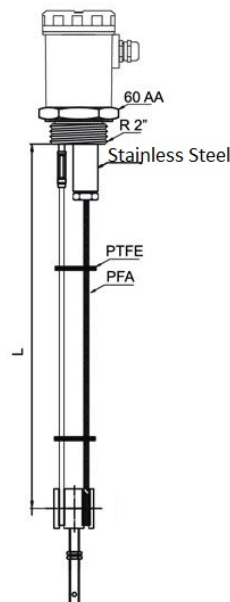

AECAP 309

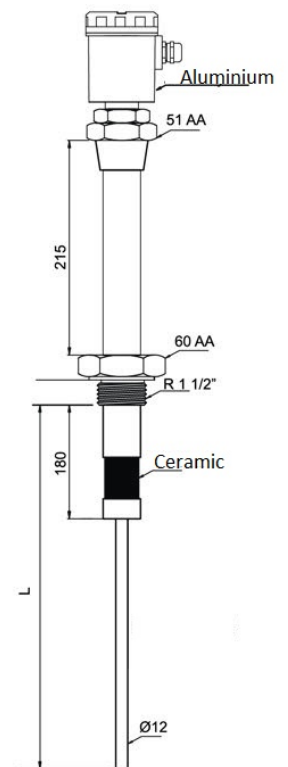

AECAP 30S



Sample Models:

		Measuring Range	Probe	Process Pressure/Temp.
<b>ADHESIVE AND ACID / BASIC LIQUIDS</b>	<p><b>AECAP 408A</b> 0...4mt. Agressive Liquids</p> 	<p><b>Double Probe</b> <b>Conductive/Insulating</b> <b>Tank</b></p>	<p><b>-1...+100 bar</b> <b>-40...+150°C</b></p>	
	<p><b>AECAP 408B</b> 0...6mt.</p> 	<p><b>Partly Insulated</b> <b>Double Probe</b> <b>Conductive/Insulating</b> <b>Tank</b></p>	<p><b>-1...+60 bar</b> <b>-40...+150°C</b></p>	
	<p><b>AECAP 408P</b> 0...6mt.</p> 	<p><b>Insulated from Body</b> <b>Double Probe</b> <b>Conductive/Insulating</b> <b>Tank</b></p>	<p><b>-1...+25 bar</b> <b>-20...+80°C</b></p>	
	<p><b>AECAP 408T</b> 0...4mt.</p> 	<p><b>Fully Insulated</b> <b>Double Probe</b> <b>Conductive/Insulating</b> <b>Tank</b></p>	<p><b>-1...+25 bar</b> <b>-40...+150°C</b></p>	

## Sample Models:

AECAP 408A

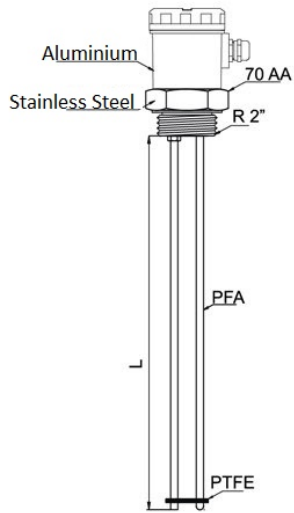

AECAP 408B

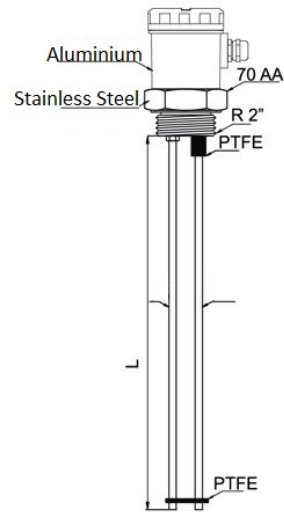

AECAP 408P

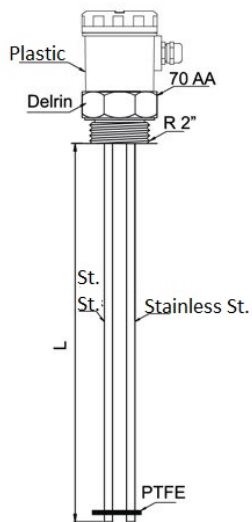

AECAP 408T

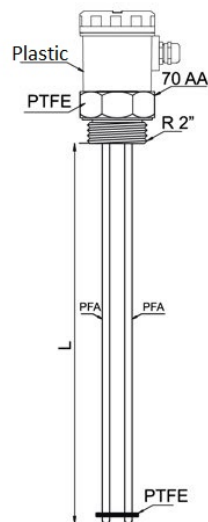



## Order Form:

Please consider sample models when coding.

<b>1</b>	<b>MODEL ECAP</b>	
	Conductive Liquids.....1 Non-Conductive Liquids .....2	Solids Particulate Materials.....3 Adhesive and Acid/Basic Materials.....4
<b>2</b>	<b>CERTIFICATE</b>	
	No .....0	
<b>3</b>	<b>PROBE TYPE (MAX. LENGHT)</b>	
	Fully Insulated Probe (Max. 4 m.).....1 Coaxial Probe, (Max. 4 m.) Ø38.....2 Coaxial Probe, (Max. 4 m.) , Ø21.....3 Partly Insulated Rope Probe (Max. 32 m.).....4 Partly Insulated Probe , (Max. 4 m.).....5 High Temperature (Max. 4 m.).....6 Complete Insulated Rope Probe (0...32m).....7 Double Electrode Probo (Max. 4 m.).....8	Double Insulated Probe..... (Max. 4 m.).....8A Partly Insulated Double Probe (Max. 4 m.).....8B Double Probe - Double Insulated (Max. 4 m.) .....8T Double Probe - Double Insulated, PVC Coaxial (Max. 4 m.).....8Tp Double Thin Probe - Double Insulated (Max. 1 m.) .....8Tm Double Insulated Probe.....S Special Insulated Probe.....x
<b>4</b>	<b>STEM LENGHT</b>	
	...mm.....0	
<b>5</b>	<b>PROCESS TEMPERATURE</b>	
	150°C (Standard).....0 200°C with Cooling Apparatus .....1	(-) 196°C For Cryogenic Tank .....2 230°C with Peek Insulated .....3 400°C with Ceramic Insulated .....4
<b>6</b>	<b>CONNECTION</b>	
	<u>Thread (ISO 228-1)</u> <u>Clamp (ISO 2852)</u> <u>ISO Flange(1092-1)</u> <u>ASA Flange (B16.5)</u> <u>Special</u>	
	1/2fBSP.....04    DN25 - PN16 ... 21 3/4fl BSP.....05    DN50 - PN16 ... 23 1fl BSP .....06 1 1/2fl BSP .....08 2fBSP .....09 1/2fl NPT.....12 3/4fl NPT.....13	DN25 - PN40 ... 26 DN32 - PN40 ... 27 DN50 - PN40 ... 28 DN80 - PN40 ... 29 DN100 - PN16 ... 30 DN50 - 150lb ... 41 DN80 - 150lb ... 43 DN100 - 150lb ... 44 <u>Flange</u> Ø70 <u>Special</u> .....x <u>Flanged</u> ..71
<b>7</b>	<b>OUTPUT</b>	
	4-20mA two wire .....19 4-20mA three wire .....20 0-10V three wire .....21 0-20mA three wire .....22	3-180 ohm .....23 10-180 ohm .....24 240-33 ohm .....25 4-20mA two wire+relay .....26 Special.....x
<b>8</b>	<b>HOUSING MATERIAL</b>	
	PlastiC (PBT).....B10p Aluminum.....B10x Stainless Steel .....B101x	Aluminum, Double Cell (B010).....3 Special.....x
<b>9</b>	<b>INSULATION MATERIAL</b>	
	PTFE.....10 PEEK.....11 Ceramic.....12 Polyamide.....13	PBT.....14 PFA.....17 Rubber.....18 FKM.....19 Special.....x
<b>10</b>	<b>CONNECTION MATERIAL</b>	
	316 Stainless Steel .....02 Brass.....03 Delrin.....09 PTFE.....10	PBT.....14 PVDF.....15 Polypropylene.....16 PVC.....17 Special.....x
<b>11</b>	<b>OPTIONAL</b>	
	No...../ 0 With By - Pass Tube...../ T	Seperable Electronic Unit...../ S Double Cell Digital Display...../ EDS02 Wall Apparatus...../W

## SAMPLE

AECAP - 101 - 300mm - 0- 06 - 21 - B10x - 10 - 02 / 0 For Cond. Liquid, L=300mm, 1fBSP, 0-10V, Aluminium Housing

# AECAP

## CAPACITIVE LEVEL TRANSMITTER



### HEAD OFFICE - FACTORY

Atatürk Sanayi Bölgesi Hadımköy Mahallesi Mustafa İnan Caddesi No: 44 Arnavutköy - İSTANBUL  
Tel: +90 212 771 01 45 (pbx) | Fax: +90 212 771 47 27  
info@ayvaz.com | www.ayvaz.com

#### **Cona Caserta/Italy**

Tel: +39 0823 187 3988  
rmolaro@ayvaz.com

#### **Ayvaz Germany Viernheim/Germany**

Tel: +49 62046014399  
germany@ayvaz.com

#### **Ayvaz Ukraine Kiev/Ukraine**

Tel: +380 44 390 57 57  
info@ayvaz.com.ua

#### **Tricorr Warsaw/Poland**

Tel: +48 530 030 810  
+48 533 603 335  
tricorr@tricorr.eu

#### **Ayvaz Azerbaijan Baku/Azerbaijan**

Tel: +99 (455) 579-84-32  
ahayatov@ayvaz.com

#### **Ayvaz Egypt Cairo/Egypt**

Tel: +20 122 819 78 29  
andrew.eid@ayvaz.com

#### **Ayvaz Gulf Dubai/U.A.E**

Tel: +971 563550822  
+971 501306871  
mideast@ayvaz.com

#### **Ayvaz China Ningbo/China**

Tel: +86 152 5830 7361  
msahin@ayvaz.com

#### **Ayvaz Kazakhstan LLP Almaty/Kazakhstan**

Tel: +7 (727) 327 97 57  
info\_kz@ayvaz.com

#### **Ayvaz N Ispirih/Bulgaria**

Tel: +359 8431 27 32  
office@ayvaz-n.eu

#### **Ayvaz Serbia Belgrade/Serbia**

Tel: +381 61 658 70 52  
yakbiyik@ayvaz.com

#### **Ayvaz Vietnam HCMC/Vietnam**

Tel: +84 89 8508345  
ggursoy@ayvaz.com

#### **Ayvaz Americas Rhode Island/USA**

Tel: +1 401 737 8380  
americas@ayvaz.com